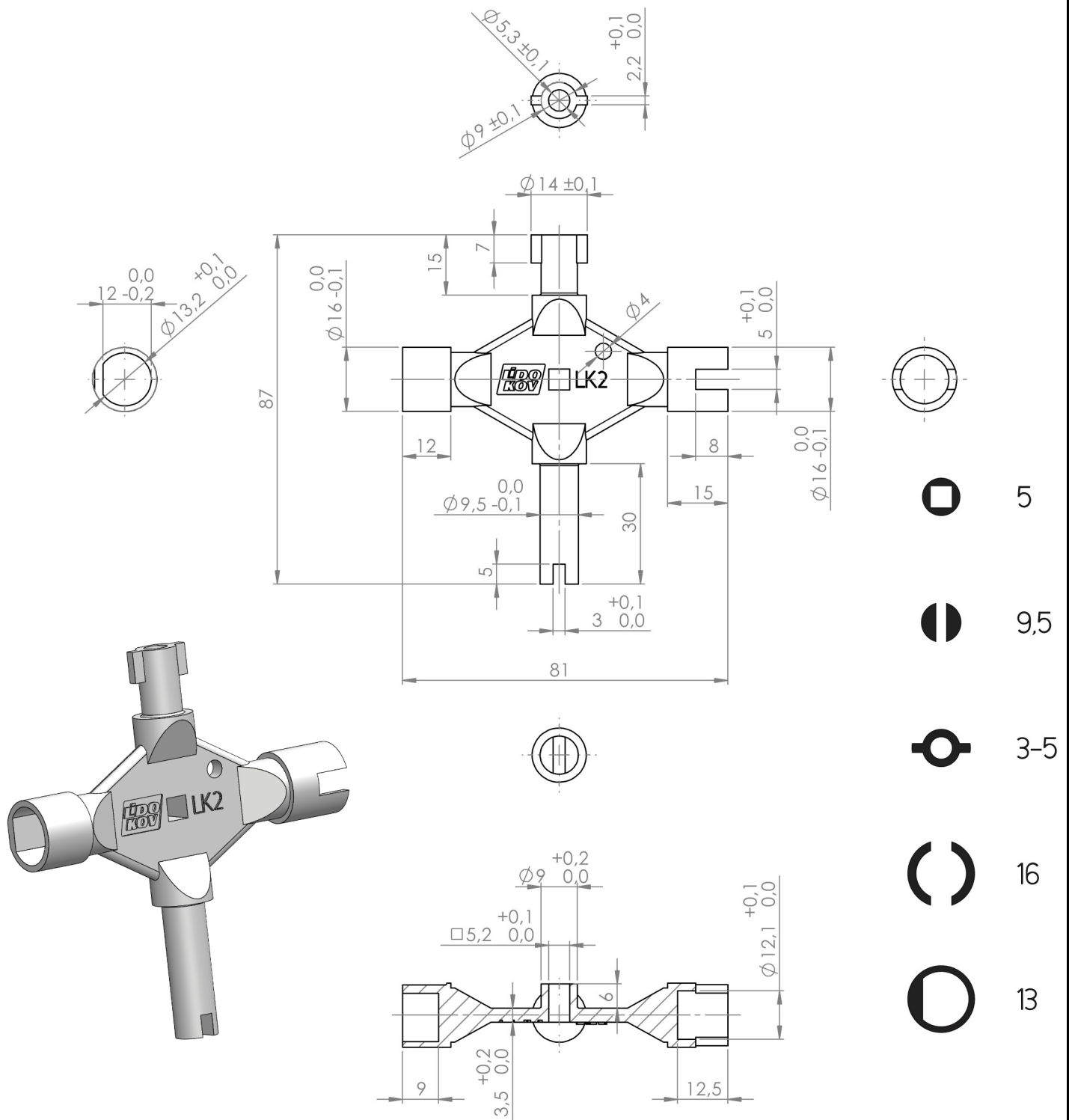

Cat.No. 01.032

**Material :** Alloy ZnAl, zinc platedOrder example : **Multi key 01.032**