











-  03.140 Triangle 6 mm
-  03.141 Triangle 8
-  03.142 Troiangle 9
-  03.143 Square 8 mm
-  03.144 Groove
-  03.145 Doppelbart 5
-  03.148 Doppelbart 3
-  03.146 Type N
-  03.147 Type L
-  03.149 Type D13



H			
22	25	28	31

**Material :**

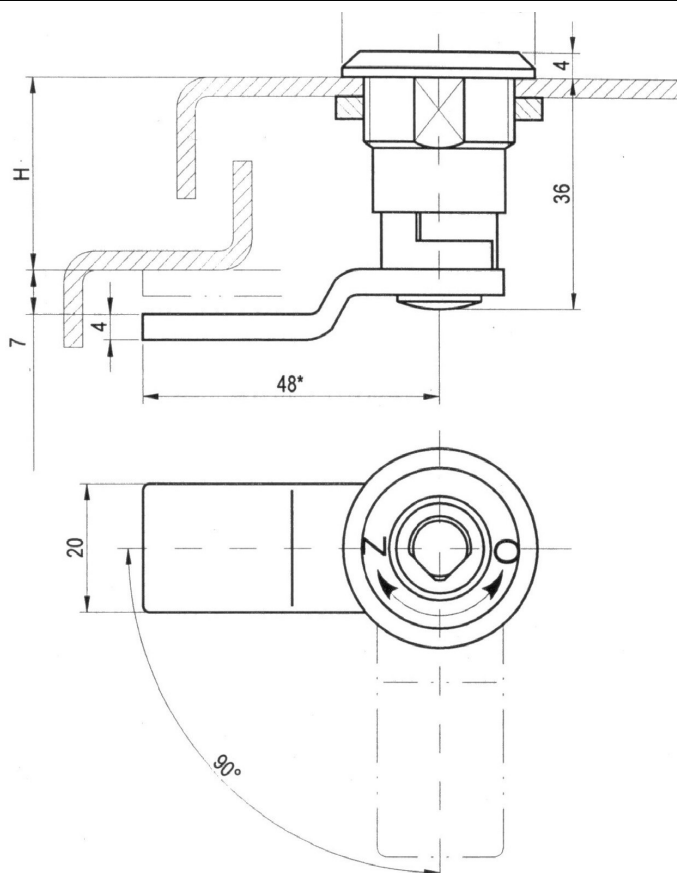
Body: alloy ZnAl, powder coating RAL : 7035/gray; 7012/gray - dark; 9005/black ;  
Nickel plated

Insert: brass

Cam : steel, zinc plated

Additional security for lock **Z8** is **Blockade RT** ( page 4-8, Cat. No. 03.150 ).

**Order example** of lock Z8 with key 03.140, dimension H = 25, RAL 7035

**Lock Z8- 03.140/25/7035**