

RT93	Catalogue number	Components	Material	Surface finish
	03.1330	body	Polyamid	RAL 9005
	03.1331	pin	Stainless steel	-
	03.1332	screws	steel- galvanized	Zn

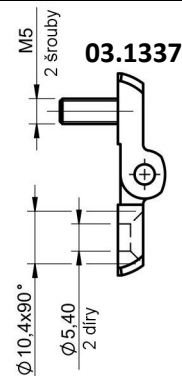

RT94	Catalogue number	Components	Material	Surface finish
	03.1335	body	Polyamid	RAL 9005
	03.1336	pin	Stainless steel	-
	03.1337	screws	steel- galvanized	Zn

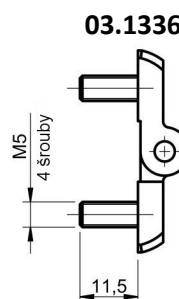
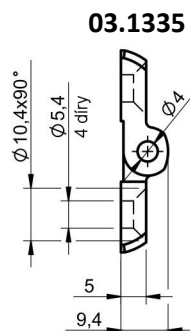
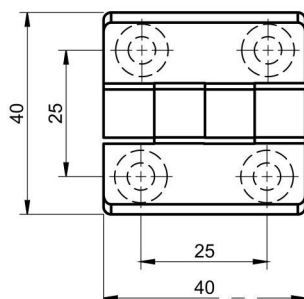
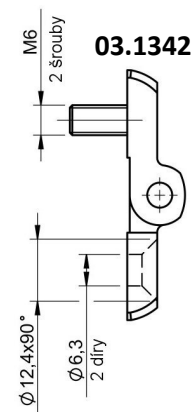
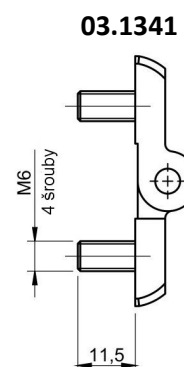
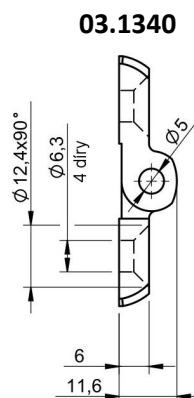
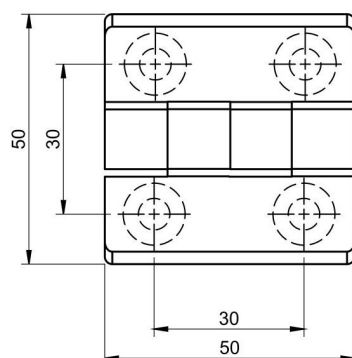

RT95	Catalogue number	Components	Material	Surface finish
	03.1340	body	Polyamid	RAL 9005
	03.1341	pin	Stainless steel	-
	03.1342	screws	steel- galvanized	Zn