

RT 84.1

Kat.č. 03.1025

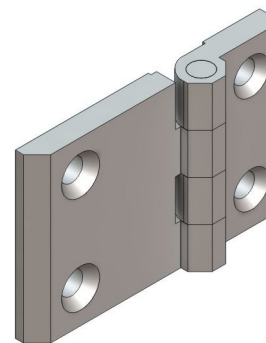

RT 84.2

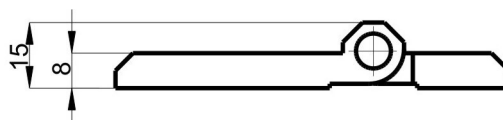
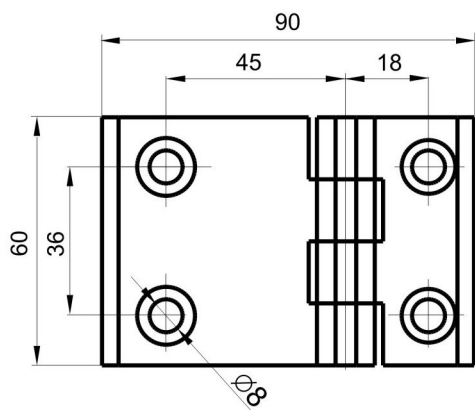
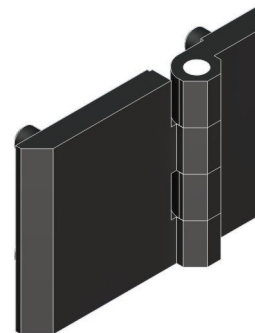
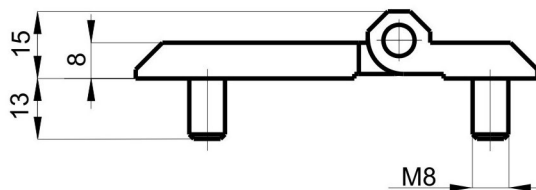
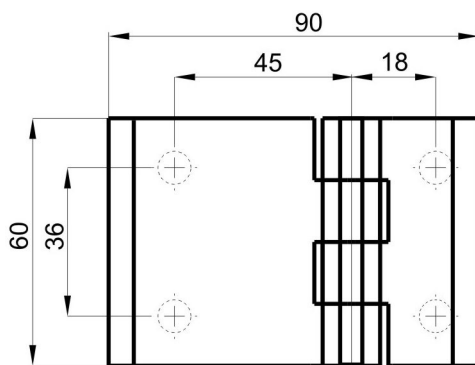

RT 84.3

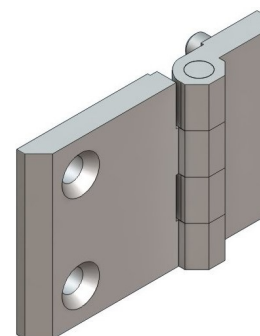
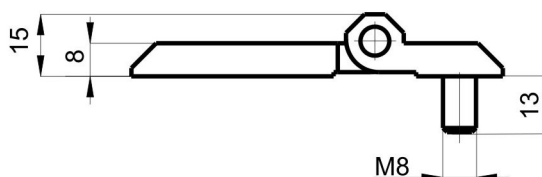
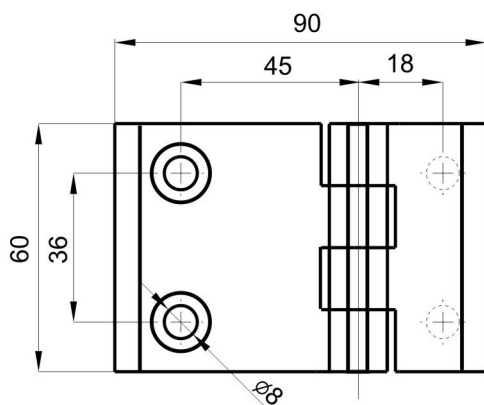

Materiál:
těleso - slitina ZnAl
čep - ocel,

Závěs	Provedení	
	chromováno	lakováno
RT 84.1	Cr	RAL 9005
RT 84.2	Cr	RAL 9005
RT 84.3	Cr	RAL 9005

Příklad objednávky chromovaného provedení verze RT 84.1 :

Závěs RT 84.1 03.1025 / Cr

L i d o k o v, výrobní družstvo, Dřevařská 1340/5, 68001 Boskovice

http:// www.lidokov.cz, e-mail : info@lidokov.cz, tel: +420 516 452341, fax.: +420 516 452570