

RT93	Katalogové číslo	Komponenty	Materiál	Povrchová úprava
	03.1330	tělo	Polyamid	RAL 9005
	03.1331	čep	Nerez ocel	-
	03.1332	šrouby	ocel- galv. pokoveno	Zn

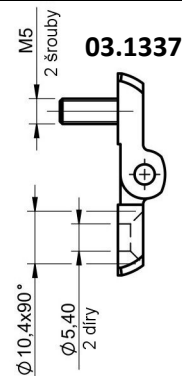

RT94	Katalogové číslo	Komponenty	Materiál	Povrchová úprava
	03.1335	tělo	Polyamid	RAL 9005
	03.1336	čep	Nerez ocel	-
	03.1337	šrouby	ocel- galv. pokoveno	Zn

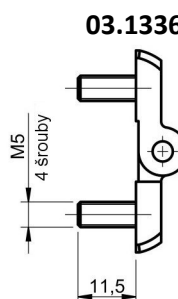
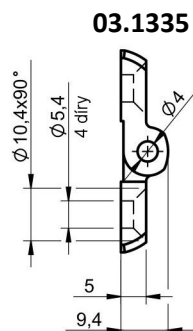
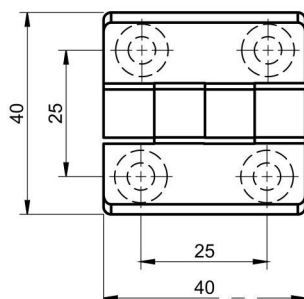
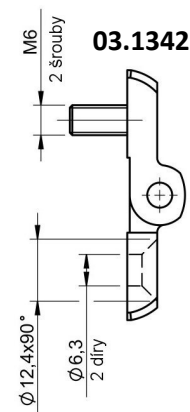
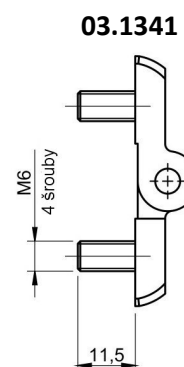
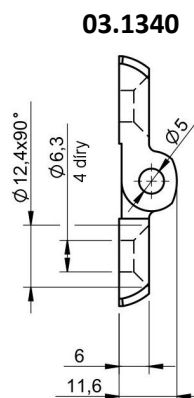
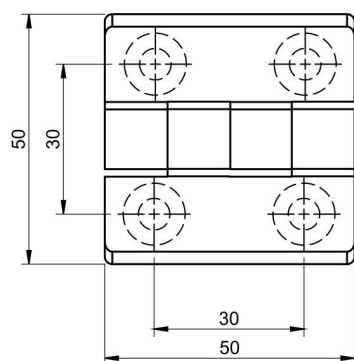

RT95	Katalogové číslo	Komponenty	Materiál	Povrchová úprava
	03.1340	tělo	Polyamid	RAL 9005
	03.1341	čep	Nerez ocel	-
	03.1342	šrouby	ocel- galv. pokoveno	Zn